



## How to hardwire the Sony DSC-S600 Digital Camera

Copyright©, PixController <http://www.PixController.com>, all rights reserved.



This document covers in detail how to modify the Sony DSC-S600 digital camera for remote shutter control from the PixController Universal or LE camera control board. Please see <http://www.pixcontroller.com> or email [support@pixcontroller.com](mailto:support@pixcontroller.com) for more information.

**Please note that if you make this modification to your Sony camera that you will void your camera's warranty. This modification can also result in damage to your digital camera if you do not follow the instructions properly.**

### Tools/Parts Needed

1. 2.4 mm #0 Philips Screwdriver & Small Flat Blade Screwdriver.
2. Fine tipped soldering iron with heat control.
3. 30 Gauge wire. Wire Wrap type wire can be purchased from your local Radio Shack store. Find one of the 3 part numbers: 278-501, 278-502, 278-503. They come in a spool of 50 feet of wire for \$2.99
4. Small tweezers.
5. Flat blade screw driver or knife.
6. PixController Universal board with Sony S40-U PIC chip, or LE board with LE II PIC chip (**Use the Sony DSC-S40 mode for the DSC-S600 camera**)

### Remove batteries and media card

Before starting your project be sure to remove the 2 AA internal batteries and the Media Card.



Remove the 2 AA batteries and Media Card

### Remove the camera case screws

Remove all 4 screws from the camera case. Be sure to place the screws in a safe place while modifying the camera.

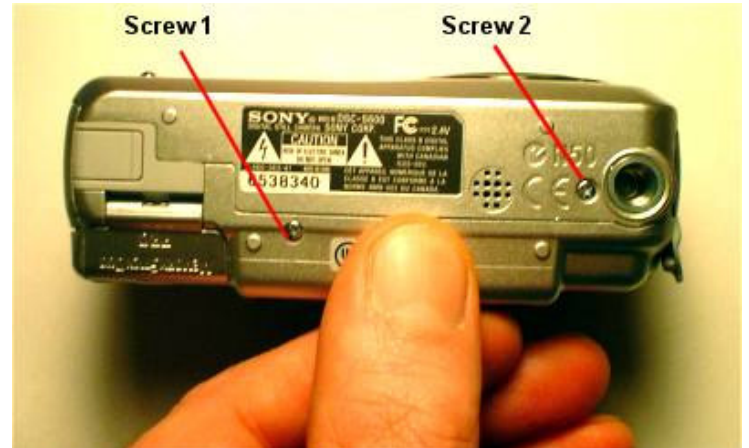

Remove screws 1, and 2 from the bottom of the camera case.



Remove screw 3 from under the USB connector door.



Remove screw 4 from under the battery door.

### **Remove the case**

Carefully remove the back of the camera case from the camera exposing the interior electronics. Next, remove the front of the camera case. This is a little harder to remove, but take your time and unsnap all of the hinges. The front of the case will be attached with a small ribbon cable, so take care as not to handle this too hard or damage the ribbon cable.



### Adding some tape...

Before you go any further you need to add some masking tape or scotch tape as shown in Figure 1 and Figure 2.

In Figure you 1 need to add some tape to hold the LCD screen in place during the camera modifications. If you do not add this the LCD will fall out and can be damaged.

In Figure 2 you need to add the tape here to mask off the flash contact points. If you do not add this tape and touch these contact points you will be shocked.

**Be sure to remove this tape when closing the case back up after your modification is finished.**



Figure 1



Figure 2

### Remove the shutter board screw

Next remove the shutter board screw as shown and carefully lift the shutter board and plastic housing from the camera.





### Remove Shutter Board

Next carefully turn the shutter board plastic housing upside down and remove the tabs holding the shutter board to the plastic housing as shown.

Lift out the shutter board and turn upright.

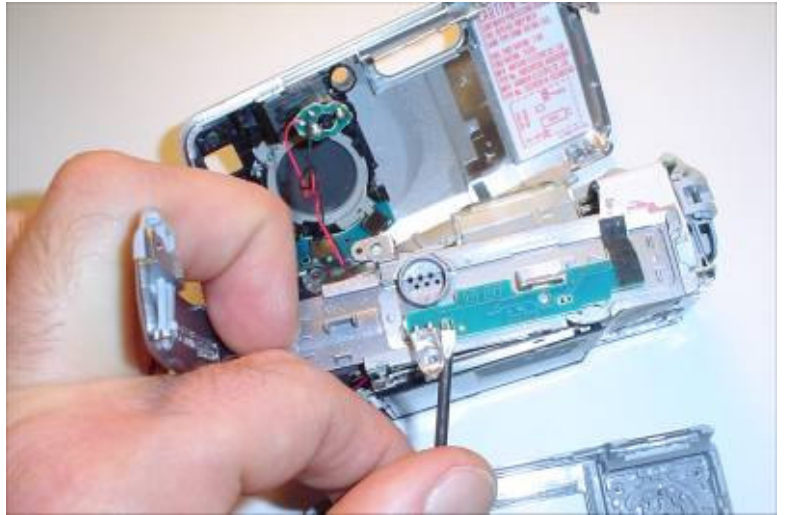

### Locating the Shutter/Power/Common Contacts

The PixController board contact points are shown in Figure 3. These are the locations where you will solder your small gauge wire and will be connected to your PixController board.

You will need a fine tipped soldering iron in order to perform this task. You may need to remove some of the fine plastic covering around the Power On/Off and Common contacts with a tool like an Exacto Knife.

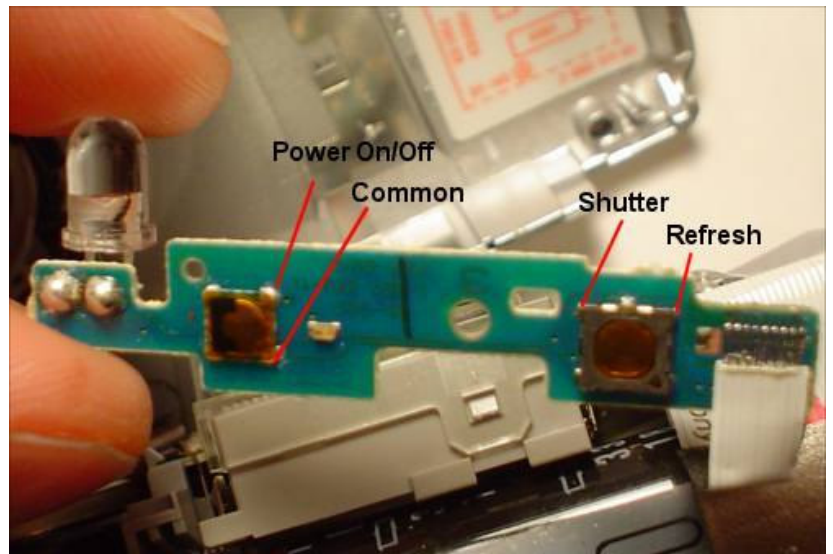

Figure 3

### Add the wires...

Add the small gauge wires as shown in Figure 4

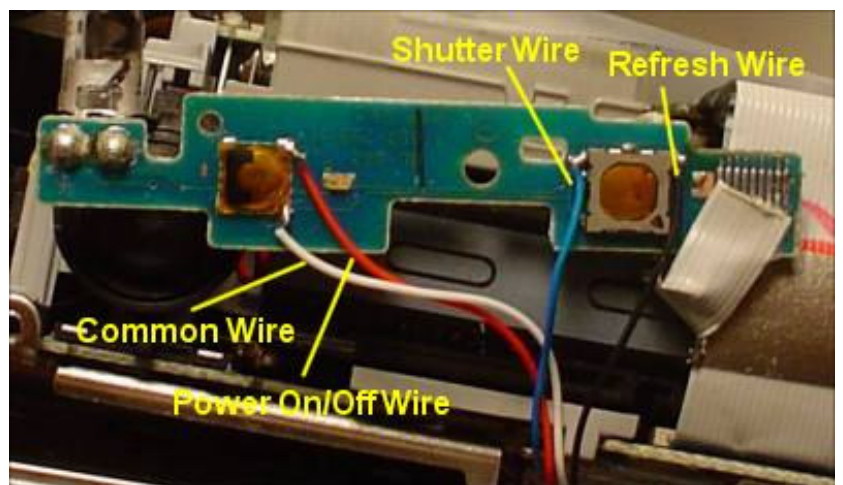

Figure 4

## Route the wires

Put the shutter board back into the plastic housing and screw the housing back to the camera. Twist the wires into a small cable and route the cable around the LCD display as shown in Figure 5. Secure the cable to the bottom with some tape.

From here you can drill a hole in the bottom of the case and export the cable there, or add a 2.5mm female connector inside of the tripod port, or even add a 3-wire servo connector. We leave this up to the person who does the modification since this is a personal preference.

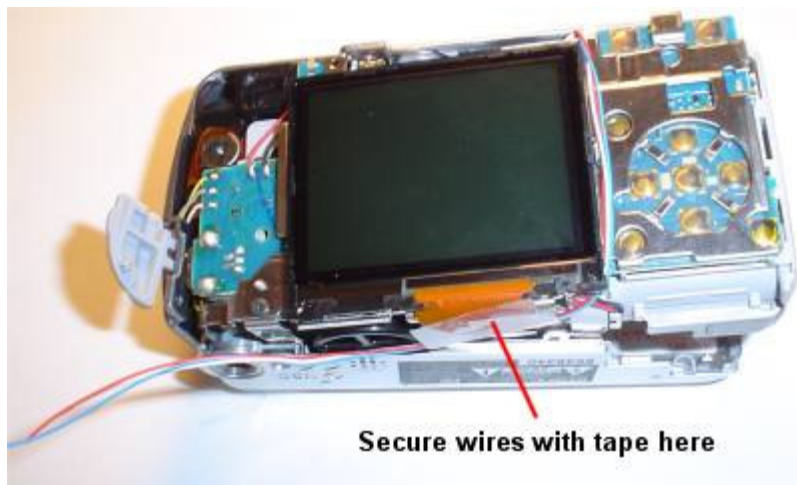

Figure 5

## Re-attach case and replace the screws

Once you are complete with this process place the camera case back together and replace the camera case screws.



## Attaching the Sony S600 to the PixController LE Board and Universal Board

### **1. Wiring your S600 camera to the PixController LE board.**

Connect the following wires to your LE board:

Camera	Point on LE Board
Shutter	Shutter on LE, J2-1
Ground	Ground on LE, J2-2
Power On/Off	Refresh on LE, J2-3
Refresh	Power on LE, J2-4

Last, remove the R17 resistor from the LE board, see: [http://www.pixcontroller.com/PixLE/PixLE\\_ResistorRemoval.htm](http://www.pixcontroller.com/PixLE/PixLE_ResistorRemoval.htm)

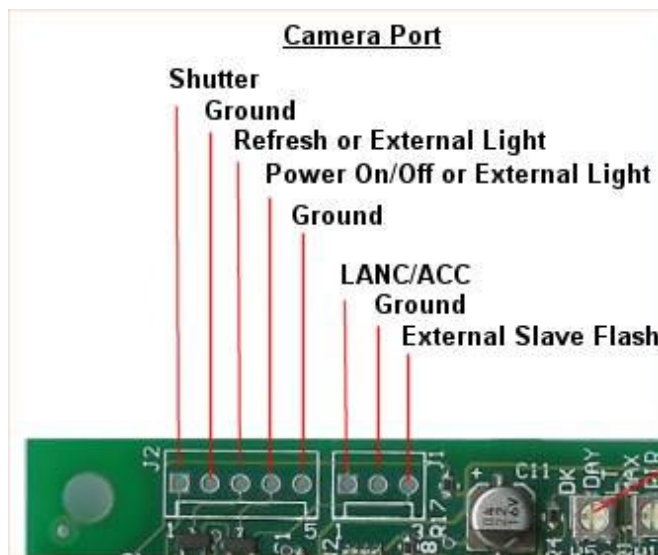

PixController LE Camera Port Diagram

**2. Wiring your S600 camera to the PixController Universal board.**

Connect the following wires to your Universal board:

Camera	Universal Board
Shutter	Shutter, J14-1, or Phone Cable Shutter Wire
Ground	Ground, J14-7, or Phone Cable Ground Wire
Power On/Off	Power, J14-3, or Phone Cable Power Wire
Refresh	Refresh, J14-2 or Phone Cable Refresh

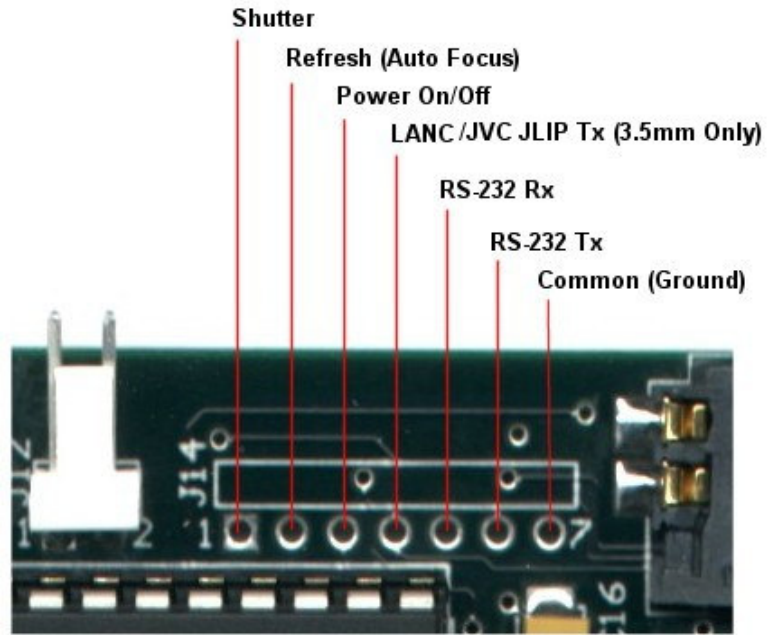

**PixController Universal Camera Port Diagram**

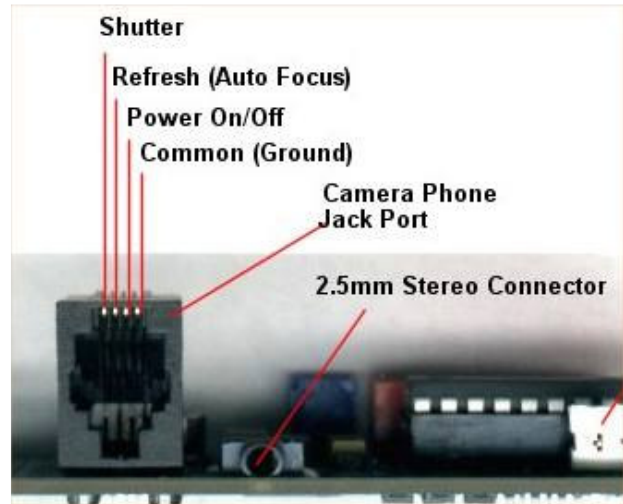

**PixController Universal Phone Port**



## Zoom Lens issue

Because of the zoom lens on the Sony S600 this can be an issue to get a good seal between the camera lens and the case as to not get flash bleed during night photos.

Figure 6 shows a simple solution to this problem by adding 3 of the Large Flash Masking Washers sold on the [www.pixcontorller.com](http://www.pixcontorller.com) web site under the camera accessories. These 3 washers can be easily glued together using Marine GOOP.



Figure 6



## **Building a trail camera**

In the photos below, Figure 7 and Figure 8 we show a completed trail camera system using a camo dipped Pelican 1020 case (note: Pelican will be selling Pelican 1020 and 1040 camo dipped cases in a Mossy Oak pattern in 2006). In this example we are using a PixController LE board with the LE II PIC chip in Sony S40 mode. The Sony S40 board settings are the same for the Sony DSC-S600 (both in the LE and Universal PixController boards). This layout uses a 9V battery holder w/ on-off switch, which can be purchased from the [www.pixcontroller.com](http://www.pixcontroller.com) web site.



**Figure 7**



**Figure 8**

## **Camera Setting**

We suggest the following Sony DSC-S600 setting for maximum trail camera performance:

- Red Eye Reduction: Off
- AF Illuminator: Off
- Auto Review: Off
- Beep: Off
- Set your Date/Time
- Setup Camera in "Program Mode"
- ISO 1000 (brightest night photos)
- Picture Quality: Fine
- AF in Monitor Mode (very important!)